

SPECIFICATIONS

ON and OFF Time Ranges

CATALOG SYMBOL	DIAL RANGE	MINIMUM SETTING	CATALOG SYMBOL	DIAL RANGE	MINIMUM SETTING
10	3.5 Sec	.37 Sec	18	15 Min	1.6 Min
11	7 Sec	.75 Sec	19	30 Min	3.2 Min
12	15 Sec	1.5 Sec	20	60 Min	6.4 Min
13	30 Sec	3.0 Sec	21	120 Min	12.8 Min
14	60 Sec	6.0 Sec	22	4 Hr	25.6 Min
15	120 Sec	12.0 Sec	23	8 Hr	51.2 Min
16	4 Min	24.0 Sec	24	15 Hr	1.7 Hr
17	8 Min	48 Sec	25	30 Hr	3.4 Hr

Setting Accuracy

Within $\pm 10\%$ of maximum range

Repeatability (Constant Voltage & Temperature)

$\pm .1\%$ of setting or 25 ms whichever is longer

Repeatability (Voltage & Temperature Variation)

Variable Voltage $\pm 1\%$ of setting

Variable Temperature $\pm 2\%$ of setting

Variable Voltage & Temperature $\pm 3\%$ of setting

Reset Time

65 ms

Cycle Progress

Pilot lights during "ON" time and "OFF" time

Voltage/Frequency

120 VAC (+10 -15%) 50/60 Hz or 120 VDC (+10 -15%)
240 VAC (+10 -15%) 50/60 Hz or 240 VDC (+10 -15%)
24 VAC 50/60 or 24 VDC

Burden

120 VAC or DC
240 VAC or DC
24 VAC or DC

Standard

2.3 VA Max.
3.5 VA Max.
2.7 VA Max.

Output Rating

Relay - 10 amp steady state

Mechanical Lifetime - Over 20 million operations

Electrical Lifetime - Contingent on load characteristics

Power Interruption

Line voltage interruptions of 20 ms or less will not reset unit

Power On Response

30 ms Max. after application of line voltage to pins A and B

Operating Temperature

0° to 60°C (+32° to +140°F)

Transient Voltage Immunity

Unaffected by 50 microseconds, 600 V peak transients superimposed on the line input

Vibration

Unaffected by 2.5G sinusoidal vibration magnitudes in both directions of three perpendicular mounting axes imposed from 10 to 1000 Hz

Laboratory Testing

U.L. Recognition E96337

C.S.A. Certification L26861

F.M. Approved J10C8A4.AF

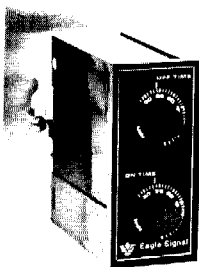
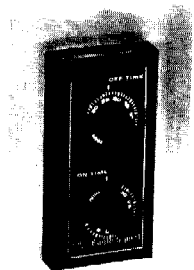
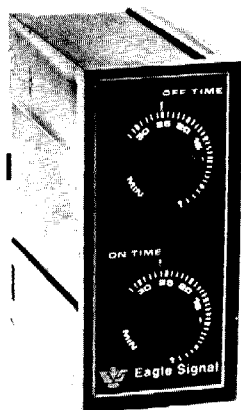

The DA100 is a solid-state ON/OFF repeat cycle timer housed in a 1/8 DIN molded NORYL® case. The timer uses CMOS integrated circuits for the timing function. Sixteen time ranges are available in any combination of ON and OFF periods. Two knobs reference to a calibrated scale provide the individual time settings. Two front mounted pilot lights indicate timing status.

All connections to the DA100 timer are made through a standard square base relay socket. Accessories are available to convert the standard surface mounted unit into a panel mounted configuration, including a version with plug-in capability.

The standard DA100, with no factory assembly options, times its OFF period first and provides an isolated double pole - double throw relay contact output. Factory assembly options can be selected to provide other features such as ON-Time First timing. Another unique optional feature available with the DA100 series is One-Cycle Timing. The use of this feature provides a timing capability previously requiring two time delay relays.

OPERATION

The timing base for each of the two timing states (ON time and OFF time), is generated by an internal oscillator set by a precision capacitor and a dial adjustable potentiometer. This technology allows accurate control over the long time ranges available with the DA100 series.

The DA100 alternately times its OFF and ON periods as long as power is applied to the control input terminal. The output contacts change state at the completion of each timing period. The DA100 resets when power is removed from the control input. Specific status details are found in the operational mode section of this product bulletin.

ACCESSORIES

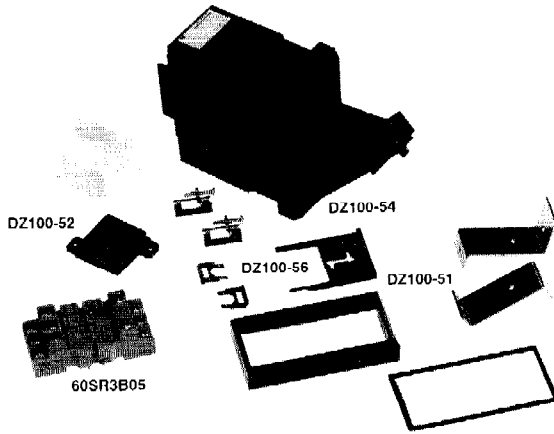

DZ100-51 BEZEL KIT for panel mounting. Kit includes bezel, bezel gasket, brackets and mounting hardware.

DZ100-52 STRAIN RELIEF KIT provides cable connection to panel mounted unit. Includes H11496 strain relief and 4270-0621 socket and hardware.

DZ100-54 PLUG-IN HOUSING for panel mounting units with plug-in convenience. Kit includes housing and mounting brackets.

DZ100-56 LATCH AND LATCH RELEASE KIT for surface mounting. Kit includes latch, spacer, latch release and mounting hardware (Use with 60SR3B05 Relay Socket).

60SR3B05 SQUARE BASE RELAY SOCKET

DA100 TERMINAL ASSIGNMENTS

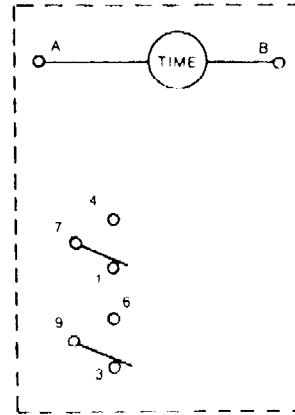

DA100 OPERATIONAL MODE

The DA100 is a repeat cycle timer which has a RESET and TIMING Mode. When the control input is open, the timer is RESET; when closed the timer is TIMING.

Of particular concern to the designer are:

1. Timer start mode (ON-time first, OFF-time first)
2. Output status in RESET
3. Output status during first timing period
4. Output status during second timing period
5. Timer status after one ON and OFF timing period

To assist in the proper selection of timer and features, refer to the accompanying chart. To determine the proper wiring for the timer selected, consult the wiring diagrams on the next page. In these diagrams, "O" indicates contact open; "X" indicates contact closed. A dashed line separates the output status during RESET from the status during TIMING

OUTPUT RESPONSE FROM DA100 TIMER

START FEATURE SELECTION	OUTPUT STATUS DESIRED		Connect Load To:
	RESET	TIMING	
00-OFF TIME FIRST	O	OXOX....	Normally open contacts
	X	XOXO....	Normally closed contacts
01-ON TIME FIRST	O	XOXO....	Normally open contacts
	X	OXOX....	Normally closed contacts
03-ONE CYCLE TIMING (OFF-TIME FIRST)	O	OX	Normally open contacts
	X	XO	Normally closed contacts

DA100 WIRING DIAGRAMS

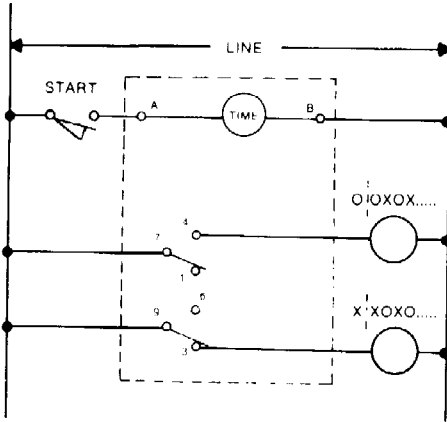

"00" FEATURE

Repeat Cycle Timing, OFF Time First. Outputs connected to the normally open relay contacts will be OFF when the timer is reset, and during the first timing period after timer start. Close control switch to start timing cycle. Open control switch to reset.

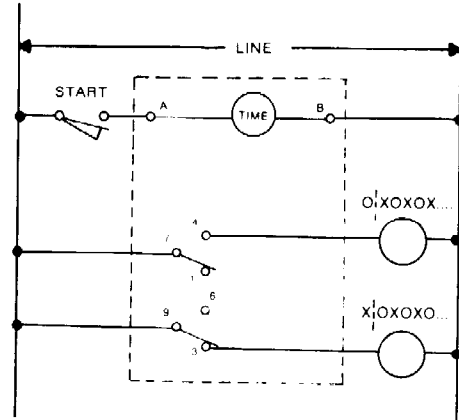

"01" FEATURE

Repeat Cycle Timing, ON Time First. Timer contacts are shown in reset and during the OFF-Time. Contacts transfer during ON-Time. Contacts will transfer as soon as control switch is closed. Timing cycle continues as long as control switch is closed. Timer resets when control switch is opened.

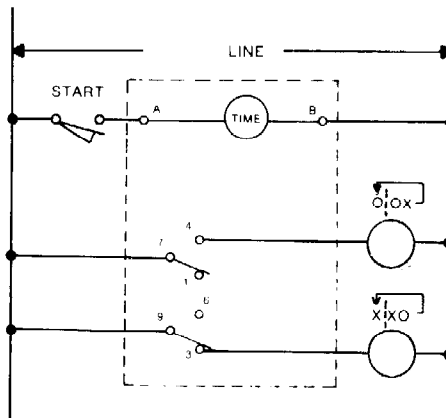

"03" FEATURE

One Cycle Timing, OFF Time First. Closing the control switch starts one OFF and one ON timing period. The timer resets after the ON period has been completed. To initiate another timing cycle, the start switch must be opened and reclosed.

MOUNTING DIMENSIONS

Panel Mount

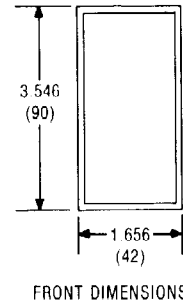
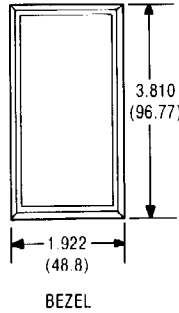
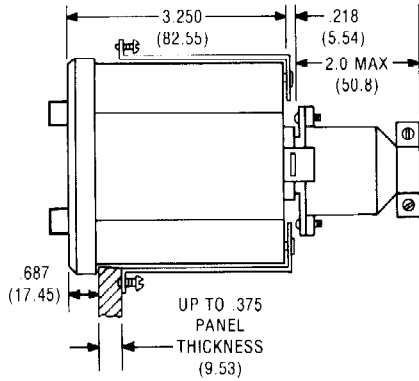

Surface Mount

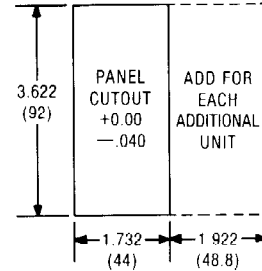
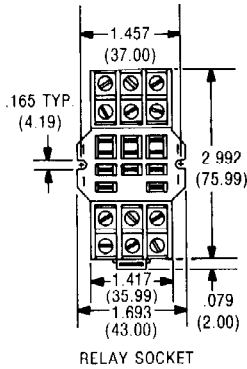
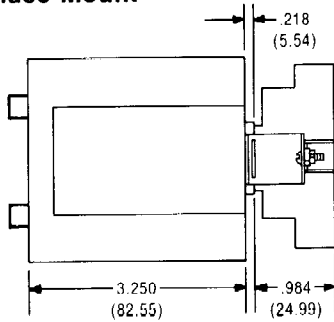

Plug-In Mount

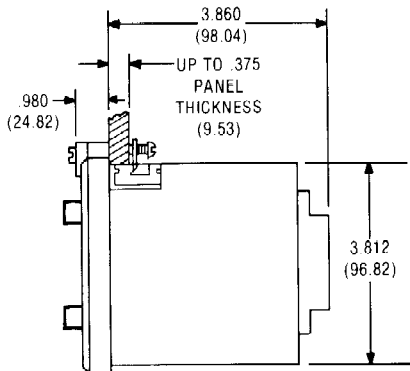

NOTE: PANELS THICKER THAN .140" REQUIRE ENLARGEMENT OF CORNERS TO ALLOW POSITIONING OF CORNER MOUNTING BRACKETS.

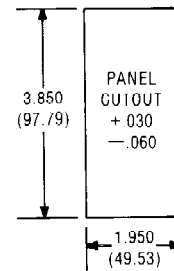
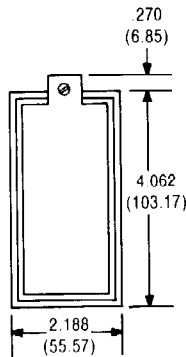

ORDERING INFORMATION

DA 10 10 A3 01

OFF Time - See Specifications For Time Range Catalog Symbol

ON Time - See Specifications For Time Range Catalog Symbol

VOLTAGE/FREQUENCY

Symbol	Description
A3	120 VAC 50/60 Hz or 120 VDC
B3	240 VAC 50/60 Hz or 240 VDC
Z3	24 VAC 50/60 Hz or 24 VDC

FEATURES

Symbol	Description
Blank	Standard, Off Time First, DPDT Relay Output
01	On Time First
03	One cycle only (Off Time First) (Requires factory components)